



rocada



# Natural

La perfección de todas las cosas naturales

*The perfection of all things natural*

Die Perfektion aller Dinge natürlich

*La perfection de tout ce qui est naturel*



ESP. Formas inspiradas en la naturaleza. La colección NATURAL es el resultado de nuestros años de experiencia. Éstas son nuestras raíces. Simplicidad y equilibrio.

ENG. Shapes inspired by nature. The NATURAL collection comes as a result of years of experience. These are our roots. Simplicity and Balance.

DE. Formen von der Natur inspiriert. Die NATURAL Kollektion ist das Ergebnis jahrelanger Erfahrung. Das sind unsere Wurzeln. Einfachheit und Ausgeglichenheit.

FR. Formes inspirées par la nature. La collection NATURAL est le fruit de nombreuses années d'expérience. Ce sont nos racines. Simplicité et équilibre.



# *Natural*



**COLECCIÓN NATURAL**  
**NATURAL COLLECTION**  
**NATÜRLICHE SAMMLUNG**  
**COLLECTION NATURELLE**

10 / 11  
NAT0610



12 / 13  
NAT8100



06 / 09  
NAT0616  
NAT0618





16 / 19  
NAT6420 75x115cm  
NAT6421 100x150cm  
▼

24 / 26  
NAT3100  
▼

20 / 23  
NAT6871  
▼

14 / 15  
NAT0705  
NAT0706  
▼







◀ NAT0616  
NAT0618

ESP. Pizarra móvil con un soporte sólido que combina acabados metálicos y de madera.

ENG. Mobile flipchart with a solid stand combining metallic and wood finishes.

DE. Mobiles Flipchart mit stabilem Ständer, der Metallic- und Holzoberflächen kombiniert.

FR. Tableau à feuilles mobiles avec un support solide combinant des finitions métalliques et du bois.

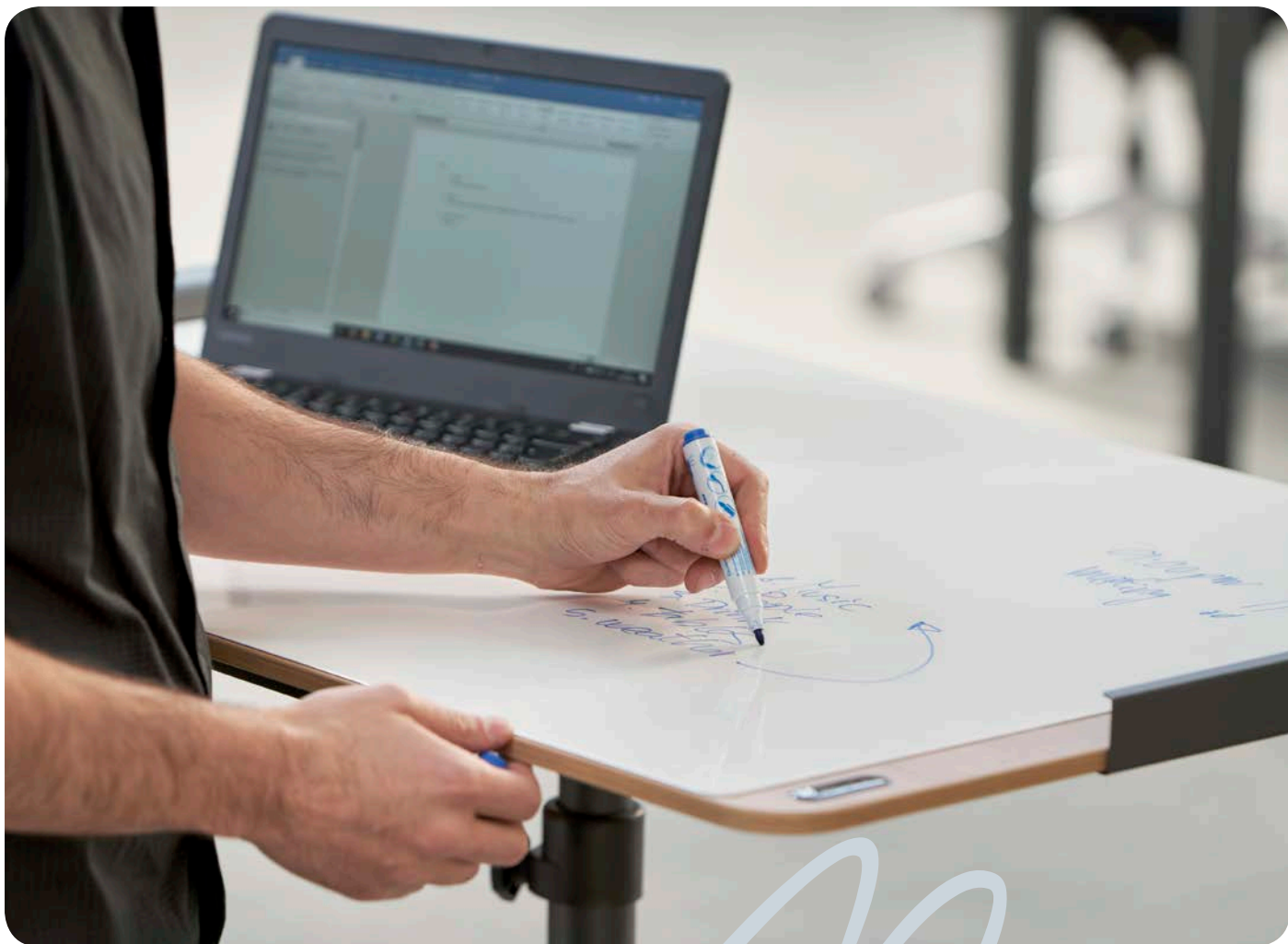

NAT0616  
NAT0618



ESP. Pizarra móvil apta para escritura con rotuladores de borrado en seco. Regulable en altura para ajustarse a la altura de cada usuario, brazos abatibles de serie y con un sistema de rotación patentado único en el mercado que permite convertir la pizarra en mesa.

ENG. Mobile board suitable for writing with dry erase markers. Adjustable in height to adjust to the height of each user, folding arms as standard, and with a patented rotation system and unique in the market that allows converting the board into a table.

DE. Mobile Tafel zum Beschreiben mit Dry-Erase-Markern. Höhenverstellbar zur Anpassung an die Körpergröße jedes Benutzers, standardmäßig mit Gelenkarmen und einem patentierten Rotationssystem, das es ermöglicht, das Board in einen Tisch umzuwandeln.

FR. Tableau mobile adapté pour écrire avec des marqueurs effaçables à sec. Réglable en hauteur pour s'adapter à la taille de chaque utilisateur, bras repliables en standard et système de rotation breveté et unique sur le marché qui permet de convertir la planche en table.





◀ NAT0618



ESP. Pizarra trípode con estructura metálica que resalta los acabados de madera.

ENG. *Tripod flipchart with a metallic structure that highlights the wood finishes.*

DE. Stativ-Flipchart mit einer Metallstruktur, die die Holzoberflächen hervorhebt.

FR. *Tableau de conférence tripode avec une structure métallique qui met en valeur les finitions en bois.*





NAT8100 ▶

ESP. Pizarras móviles que permiten escribir en ambos lados. Los acabados de madera son la expresión de su poder.

ENG. Mobile whiteboard that allows for writing on both sides. The wood finishes are an expression of its power.

DE. Mobiles Whiteboard, das beidseitiges Schreiben ermöglicht. Die Holzoberflächen sind Ausdruck seiner Kraft.

FR. Tableau blanc mobile permettant d'écrire des deux côtés. Les finitions en bois sont une expression de sa puissance.





ESP. A veces la presentación es lo que más importa. Expositores con un alma fuerte para expresar las ideas más delicadas.

ENG. Sometimes the presentation is what matters the most. Displays with a strong soul to express the most delicate.

DE. Manchmal ist die Präsentation das Wichtigste. Displays mit einer starken Seele, um die zartesten auszudrücken.

FR. Parfois, la présentation est ce qui compte le plus. Affiche avec une âme forte pour exprimer le plus délicat.

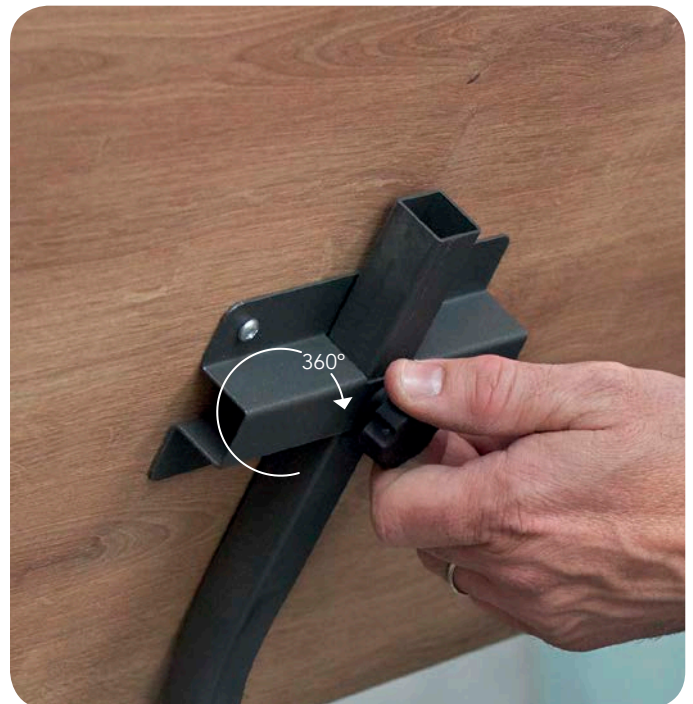
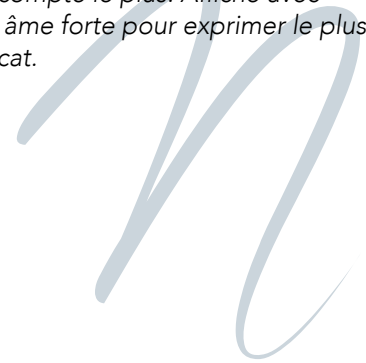



◀ NAT0706  
Tamaño A3  
A3 size  
A3 Größe  
Format A3



◀ NAT0705  
Tamaño A4  
A4 size  
A4 Größe  
Format A4

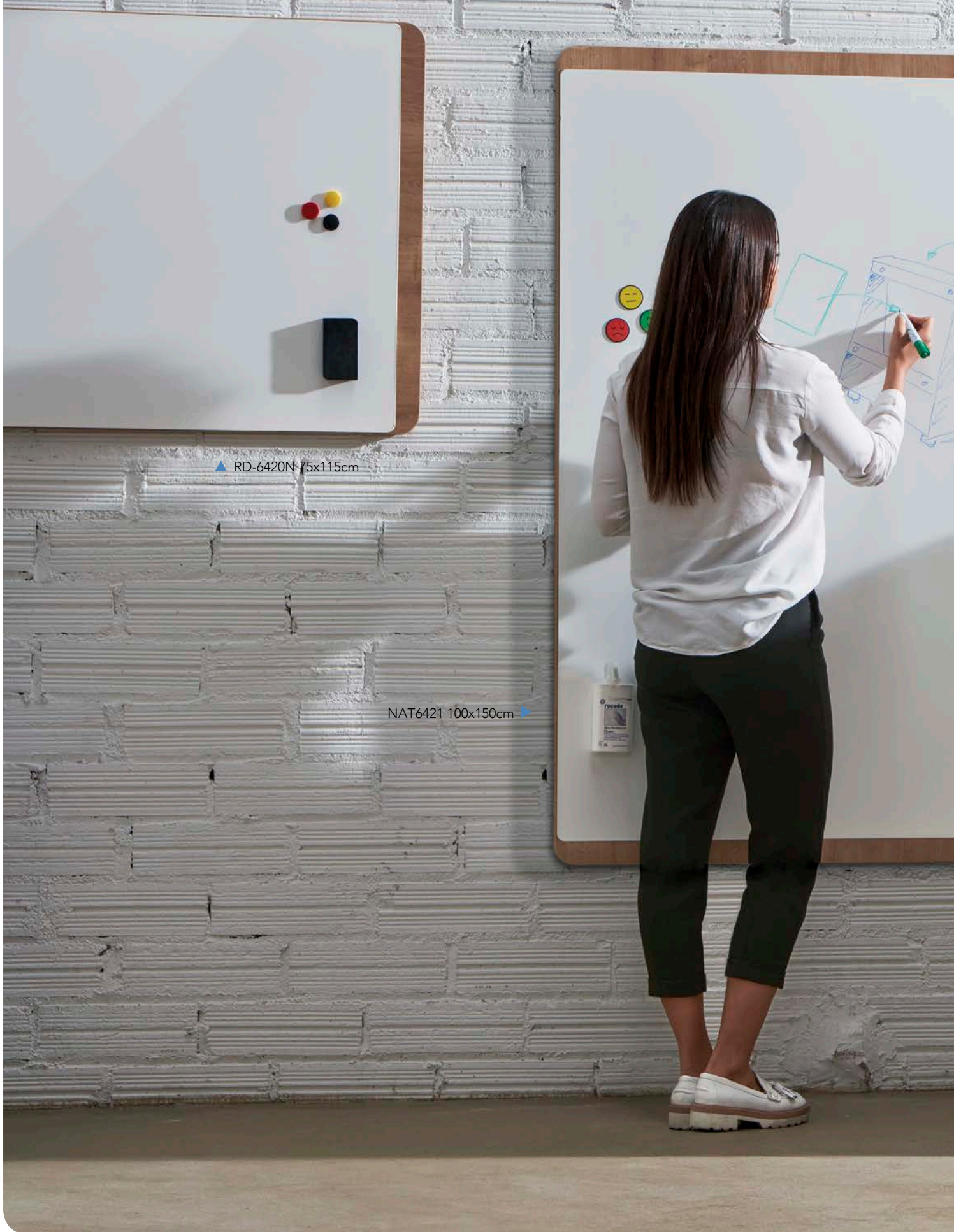

▲ RD-6420N 75x115cm

NAT6421 100x150cm ▶

ESP. Porque la información es importante. El diseño de la pizarra NATURAL permite centrarse en lo que más importa.

ENG. Because information is king. The NATURAL whiteboard's design allows for focusing on what matters the most.





DE. Weil Information König ist. Das Design des NATURAL Whiteboards ermöglicht für die Konzentration auf das, was am wichtigsten ist.

FR. Parce que l'information est roi. La conception du tableau blanc NATURAL permet pour se concentrer sur ce qui compte le plus.





NAT6420 75x115cm ▲

ESP. Pizarra de pared multifuncional con un equilibrio entre la superficie magnética y sus acabados en madera. Gracias a su diseño con fijación magnética, permite colocarlas en vertical y horizontal. Totalmente compatibles con los rotuladores de borrado en seco. Una pizarra que dará un toque más moderno, más cálido y más natural a su oficina.

ENG. Multifunctional wall slate with a balance between the magnetic surface and its wood finishes. Thanks to its magnetic fixing design, it allows to place them vertically and horizontally. Fully compatible with dry erase markers. A blackboard that will give a more modern, warmer and more natural touch to your office.

DE. Multifunktionaler Wandschiefer mit einem Gleichgewicht zwischen der magnetischen Oberfläche und den Holzoberflächen. Dank des magnetischen Befestigungsdesigns können sie vertikal und horizontal platziert werden. Voll kompatibel mit Dry Erase Markern. Eine Tafel, die Ihrem Büro eine modernere, wärmere und natürlichere Note verleiht.

FR. Ardoise murale multifonctionnelle équilibrant la surface magnétique et les finitions en bois. Grâce à son design de fixation magnétique, il permet de les placer verticalement et horizontalement. Entièrement compatible avec les marqueurs effaçables à sec. Un tableau qui donnera à votre bureau une touche plus moderne, plus chaleureuse et plus naturelle.





▲ NAT6871

Soporte + pizarra  
Support + whiteboard  
Unterstützung + Whiteboard  
Support + tableau blanc

ESP. Expresarnos es natural. El soporte giratorio NATURAL le permite mostrar todas sus necesidades, presentaciones y sentimientos.

ENG. Expressing ourselves is natural. The NATURAL revolving support allows you to showcase all your needs, presentations and feelings.



DE. Sich auszudrücken ist natürlich. Die NATÜRLICHE Drehunterstützung ermöglicht es Ihnen, alle Ihre Bedürfnisse, Präsentationen und Gefühle zu präsentieren.

FR. S'exprimer est naturel. Le support rotatif NATURAL vous permet de mettre en valeur tous vos besoins, présentations et sentiments.

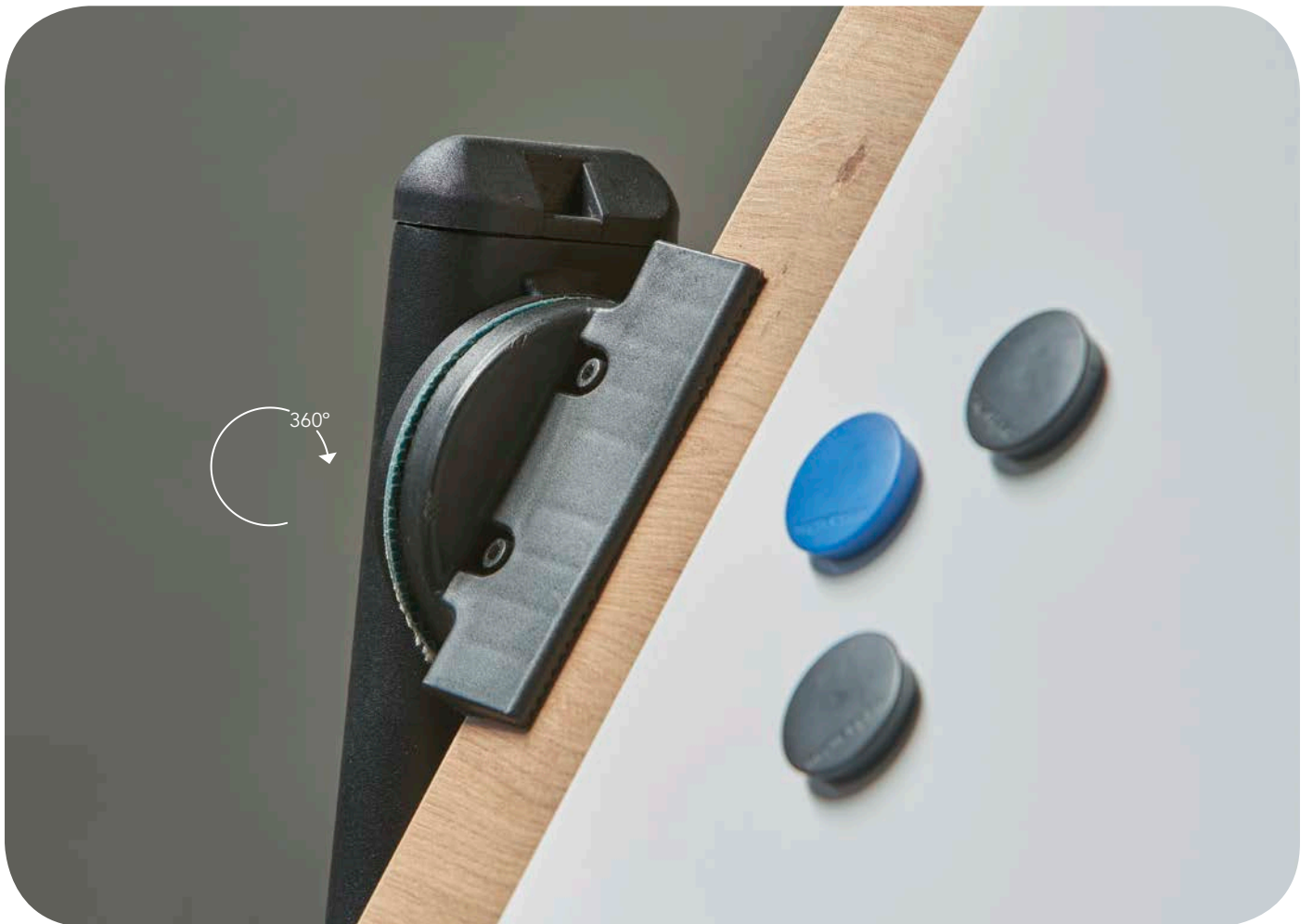

Sistema de rotación de 360° · Free rotation system 360° · 360°-Rotationssystem · Système de rotation libre à 360°



▲ NAT6871

ESP. Soporte móvil de doble cara con pizarras lacadas en ambos lados.

ENG. Mobile double-sided support with lacquered boards on both sides.

DE. Mobile doppelseitige Auflage mit beidseitig lackierten Brettern.

FR. Support mobile double face avec des panneaux laqués des deux côtés.



ESP. Soporte simple y fuerte para la gama SKINWHITEBOARD. Todo el poder de los acabados de madera se presenta en toda la gama de pizarras Skin. Deslumbrantes soluciones de comunicación.

ENG. Simple and strong support for the SKINWHITEBOARD range. All the power of wood finishes is featured throughout the skin range. Dazzling communication solutions.





NAT3100 ▲

Pizarra Skinwhiteboard no incluida.

Skinwhiteboard not included.

Tafel nicht enthalten

Tableau Skinwhiteboard non inclus.

DE. Einfache und starke Unterstützung für die SKINWHITEBOARD. Die ganze Kraft von Holzoberflächen ist in der gesamten Hautlinie zu spüren. Verblüffende Kommunikationslösungen.

FR. Support simple et puissant pour la gamme SKINWHITEBOARD. Toute la puissance des finitions en bois est présente dans toute la gamme de peaux. Des solutions de communication éblouissantes.



ESP. Admite pizarras Skin Pro y Skin Colour.

ENG. Allows to install the Skin Pro and Skin Colour whiteboards.

DE. Ermöglicht die Installation von Skin Pro und Skin Colour Whiteboards

FR. Permet d'installer des tableaux Skin Pro et Skin Color.



NAT3100 ▲

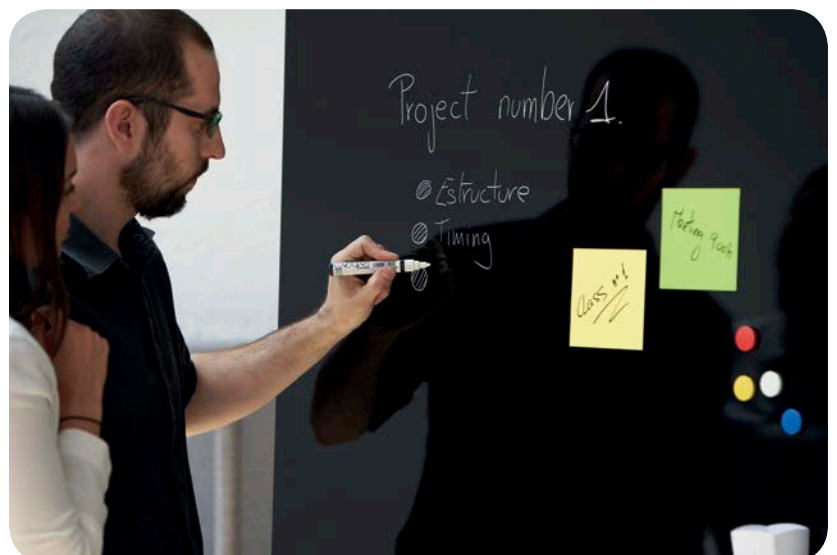
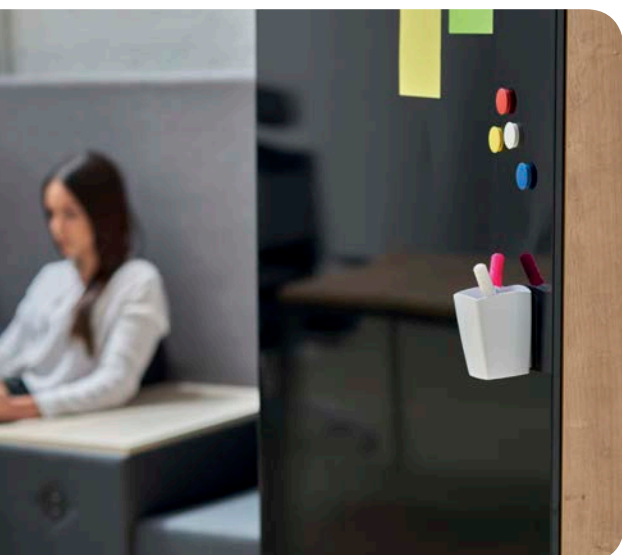

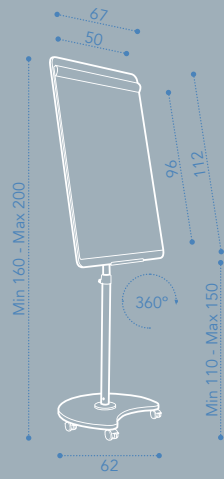

▲ NAT0618

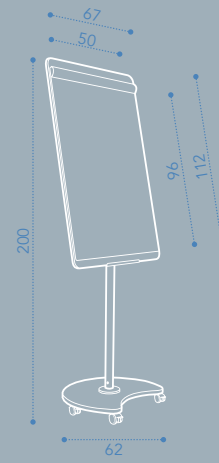

▲ NAT0616

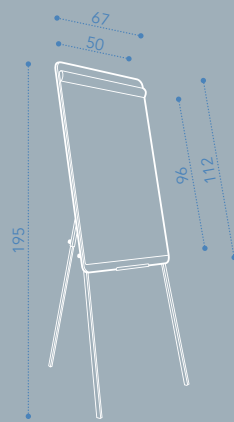

▲ NAT0610

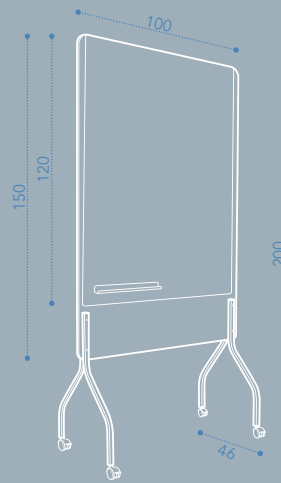

▲ NAT8100

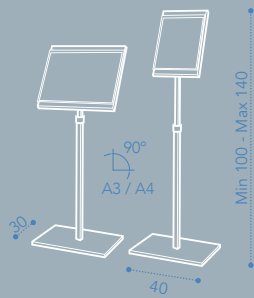

▲ NAT0706 A3 size / NAT0705 A4 size

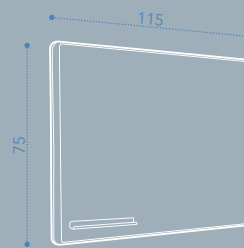

▲ NAT6420 75x115cm

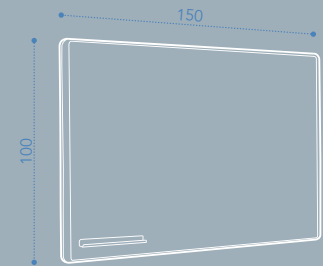

▲ NAT6421 100x150cm

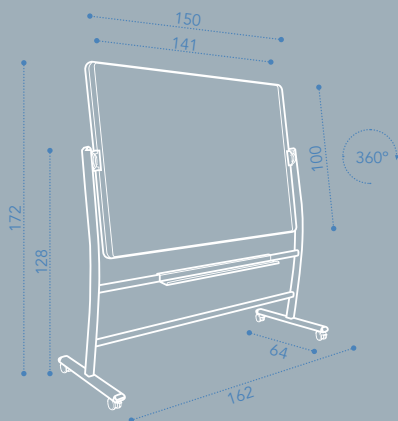

▲ NAT6871

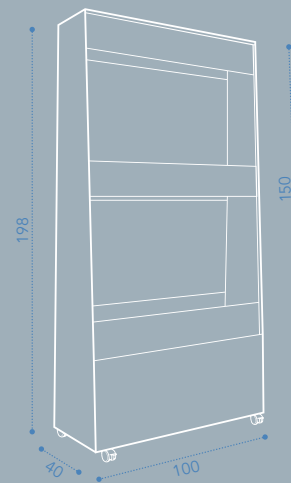

▲ NAT3100



# rocada

**Rocada Spain**  
rocada@rocada.com  
www.rocada.com

**Rocada Deutschland GmbH**  
info@rocada.de  
www.rocada.de



ISO 14001

BUREAU VERITAS  
Certification



© Certified  
suppliers with  
Forest  
Stewardship  
Council



Certified  
suppliers with  
the Programme  
for the Endorsement  
of Forest Certification  
schemes



Distribuido por:  
Distributed by:  
Vertrieben von:  
Distribué par:

